

KMT36H 360° Angular Sensor



- AMR Sensor with 360° capability
- TDFN outline 2.5x2.5x0.75 mm³
- Three 120° phase-shifted signals
- Moderate field strength requirements

DESCRIPTION

The **KMT36H** is a magnetic field sensor utilizing the anisotropic magneto resistance effect. Therefore the sensor is sensing the **magnetic field direction** rather than the magnetic field strength. The sensor contains three Wheatstone bridges rotated by 120°. A rotating magnetic field (typical strength 25 kA/m in the sensor plane) will result in three sinusoidal output signals with a period of 180°, phase shifted by 60° field angle. By use of a modified *atan* algorithm the field angle can be calculated with high accuracy.

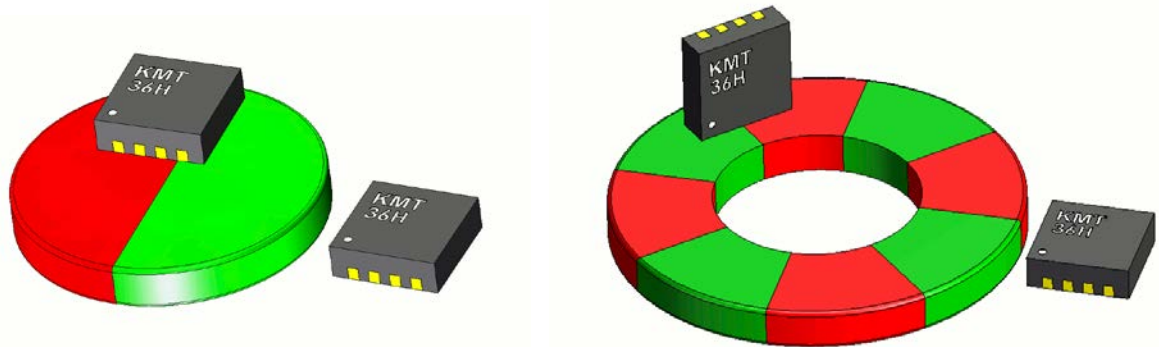

As an unique feature, the KMT36H is able to measure full 360° by utilizing an additional magnetic field which is generated by a planar coil that is integrated on the chip. The 180°/360° determination is done by a simple sign distinction and may be computed periodically or only once at power up.

FEATURES

- Ideal for harsh environments due to magnetic sensing principle
- Contactless absolute angular measurement over 360°
- Accuracy better than +/- 0.5°
- Three bridge signals with 120° phase difference
- Tiny TDFN-housing 2.5 x 2.5 x 0.8 mm³

APPLICATIONS

- Absolute angle measurement
- Potentiometer replacement
- Motor motion control
- Camera positioning
- Robotics

KMT36H 360° Angular Sensor

CHARACTERISTIC VALUES

Parameter	Condition	Symbol	Min	Typ	Max	Unit
Mechanical dimensions - TDFN						
Length		X		2.5		mm
Width		Y		2.5		mm
Height		Z		0.75		mm
Mechanical dimensions - SO8						
Length		X		4.9		mm
Width		Y		6.0		mm
Height		Z			1.75	mm
Operating limits						
Supply voltage		V _{CC}		5	12	V
Coil current	T = 25 °C, H = 25 kA/m	I _{COIL}		20	50	mA
Operating temperature			-40		+125	°C
Storage temperature			-40		+125	°C

Parameter	Condition	Symbol	Min	Typ	Max	Unit
Sensor specification						
Applied magnetic field	2), 3)	H	15	25	60	kA/m
Bridge resistance	T = 25 °C	R _B	2.4	3.0	3.6	kΩ
max. signal range	T = 25 °C, H = 25 kA/m	$\Delta V/V_{CC}$	18	22	26	mV/V
Offset voltage 4)	T = 25 °C	V _{OFF} /V _{CC}	-3		+3	mV/V
Hysteresis 1) (Repeatability)	H = 25 kA/m	Hyst		0.15	0.30	deg
Accuracy 1)	H = 25 kA/m	$\Delta\alpha$		0.15	0.30	deg
TC of amplitude	H = 25 kA/m, 5)	TC _{AMP}		-0.32		%/K
TC of bridge resistance	5)	TC _R		+0.32		%/K
Coil resistance	T = 25 °C	R _{COIL}	75	100	150	Ω
Thermal resistance (junction-ambient)	T _{amb} = 25°C, 6)	R _{thJA}		280		K/W

- 1) Hysteresis and accuracy are depending nearly inversely proportional on the magnetic field strength. The accuracy is defined as the max. angular difference between actual field angle and measured angle calculated from the third and fifth harmonics of the Fourier spectrum. The hysteresis is defined as angular difference between left and right turn.
- 2) Generated with reference magnet 67.044 Magnetfabrik Bonn (25 kA/m @ 5.2 mm distance).
- 3) Minimum value depends on decreasing accuracy, upper limit on decreasing coil influence. Both are no absolute limits, but depend on the given application requirements.
- 4) Offset voltages measured as difference voltages V_{O1}-V_{O2}, V_{O2}-V_{O3} and V_{O3}-V_{O1} in relation to V_{CC}.
- 5) Reference temperature T_{ref} = -25 °C, calculated from values at -25°C and +125 °C
- 6) TDFN soldered on standard test PCB, heat sink without solder connection

KMT36H 360° Angular Sensor

BLOCK DIAGRAM

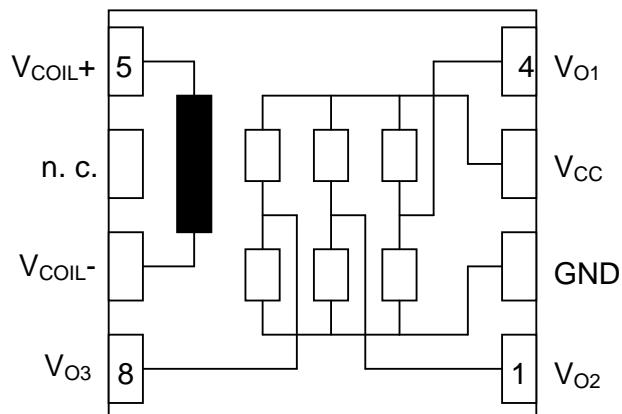

Figure 1: internal and external connections (TDFN and SO8, Chip)

SENSOR OUTLINE

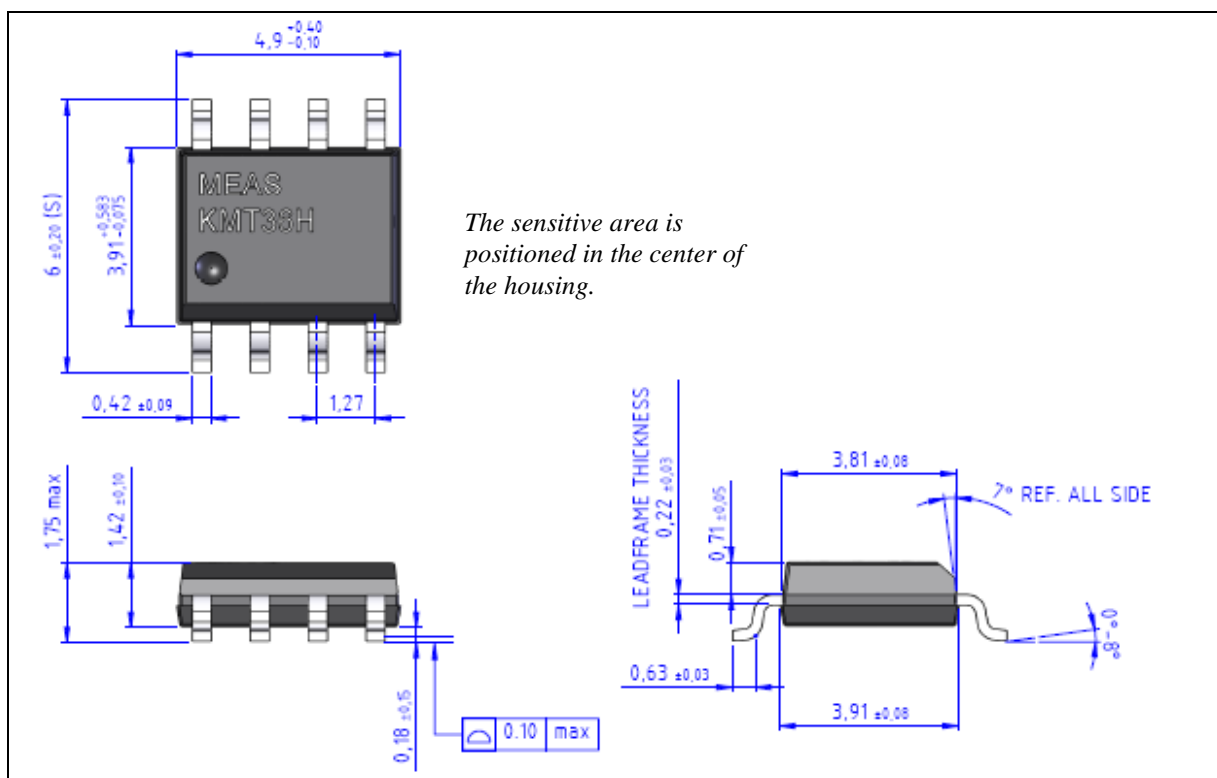

Figure 2: SO8 outline

KMT36H 360° Angular Sensor

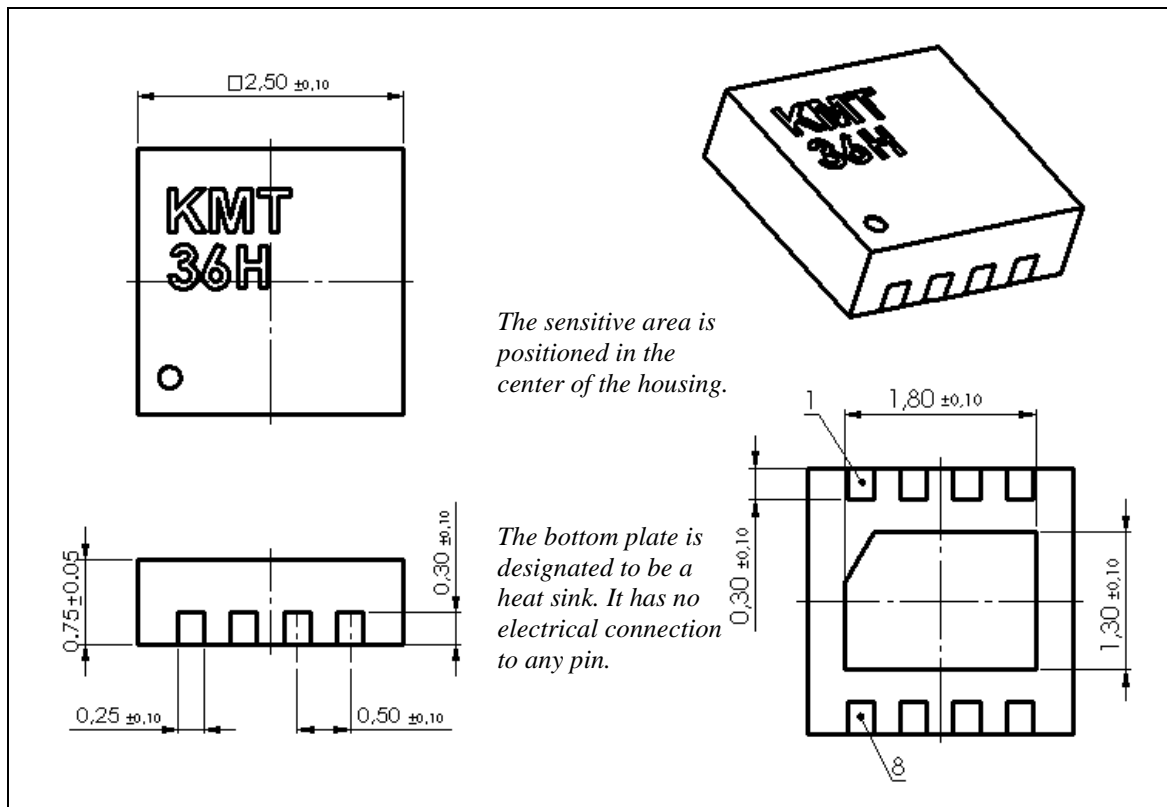
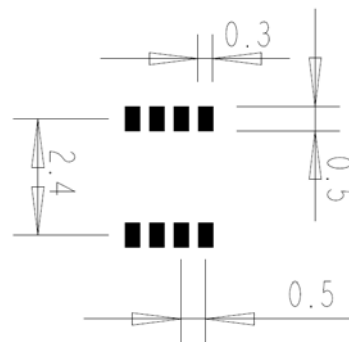

Figure 3: TDFN outline

Pin Assignment for TDFN and SO8:

Pin	Symbol	Function
1	V _{O2}	signal output 2
2	GND	negative supply voltage
3	V _{CC}	positive supply voltage
4	V _{O1}	signal output 1
5	V _{COIL+}	positive coil input
6	n. c.	not connected
7	V _{COIL-}	negative coil input
8	V _{O3}	signal output 3

Recommended Solder Layout for TDFN:



Recommended solder reflow process according to IPC/JEDEC J-STD-020D (Pb-Free Process)

TAPE AND REEL PACKAGING INFORMATION

DESCRIPTION	REEL SIZE	UNITS/REEL	PIN 1 ORIENTATION	NOTE
KMT36H	7"	3,000	Top-right of sprocket hole side	
KMT36H/SO	13"	2,500	Top-left of sprocket hole side	

KMT36H 360° Angular Sensor

TYPICAL PERFORMANCE CURVES

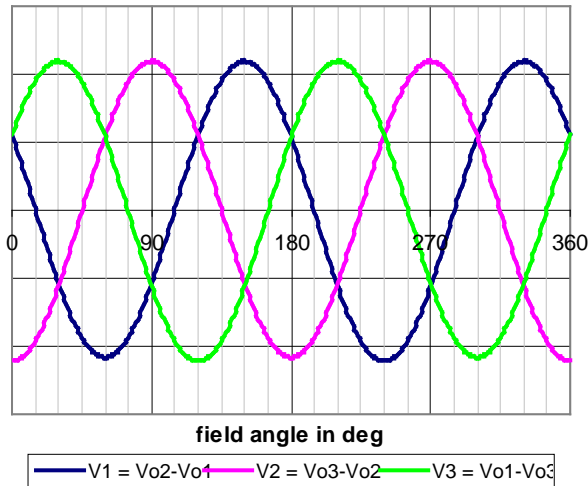

Figure 3: output voltages

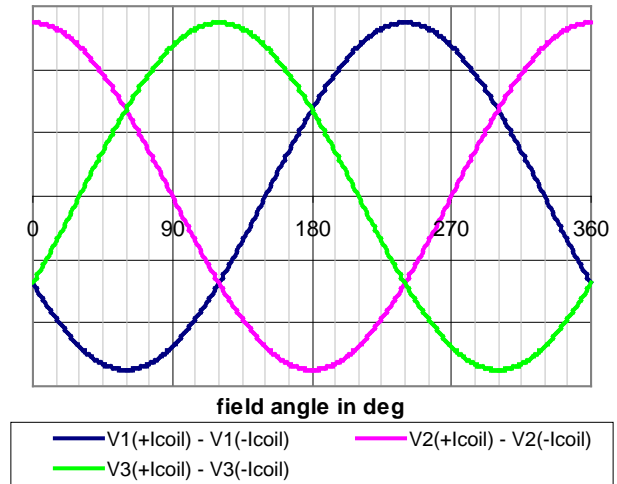

Figure 4: output voltage change due to coil influence

SIGNAL EVALUATION

180° EVALUATION

As output voltages (V_1 , V_2 , V_3) we use the three possible differences between the three signal outputs (see fig. 3). At first the true offsets must be subtracted from the raw signals. The field angle α in a 180°-range then can be calculated in the following manner:

$$\alpha = \frac{1}{2} \cdot \arctan \left(\frac{2 \cdot \frac{V_n}{V_m} + 1}{\sqrt{3}} \right)$$

Using the three possible combinations of output signals ($m, n = 1, 2 ; 2, 3 ; 3, 1$) three results are obtained, which can be averaged to increase accuracy. Comparing the three results gives additional information about their reliability.

360° EVALUATION

In order to distinguish between α and $\alpha+180^\circ$ two additional measurements are needed: one with positive, the other with negative coil current. In the next step the change in the signals due to the influence of the coil current must be calculated. The sign of these coil-induced output voltage changes gives the 360°-information by case differentiation (see figure 4). In principle, this 360° discrimination needs to be computed only once at start up. Nevertheless, it is recommended to check the measurement periodically.

