

SPECIFICATIONS:

Industry Standard Dimensions

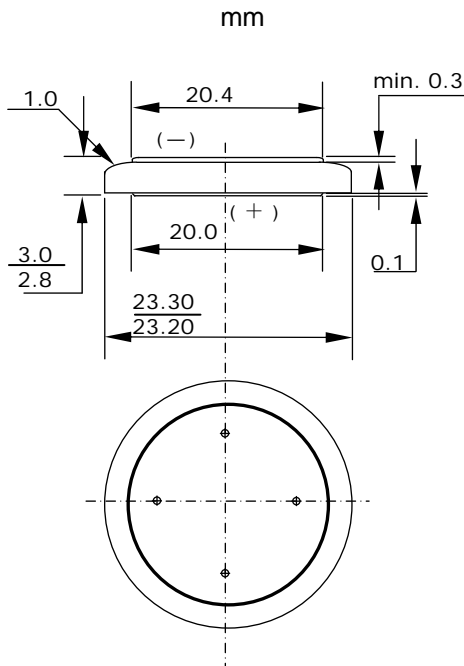

Chemical System:	Zinc Air (Zn/O ₂)
Identification:	IEC-PR2330
Tab Color:	Green
Build Standard:	Factory Internal (Ref. IEC60086-2011)
Nominal Voltage:	1.45 Volts
Capacity	900 mAh (to 0.90 volts) (Rated at 100 ohms at 20°C/ 60%RH)
Capacity Retention:	> 85%(after 3 years)
Max. Current Continuous :	25 mA
Max. Current Pulse:	80 mA @ 1s
Tab Sealing Arrangements:	On Cathode Can. See picture above.
Shelf Life:	3 years
Operation Temp:	0°C to 50°C
Typical Weight:	3.8 grams (0.13 oz.)
Typical Volume:	1.21 cubic centimeters (0.07 cubic inch)
Impedance:	≤ 0.8 ohms (at AC 1000Hz)

DISCHARGE CHARACTERISTICS AT 100Ω
25°C 60%RH(Discharged 24 hours/day)

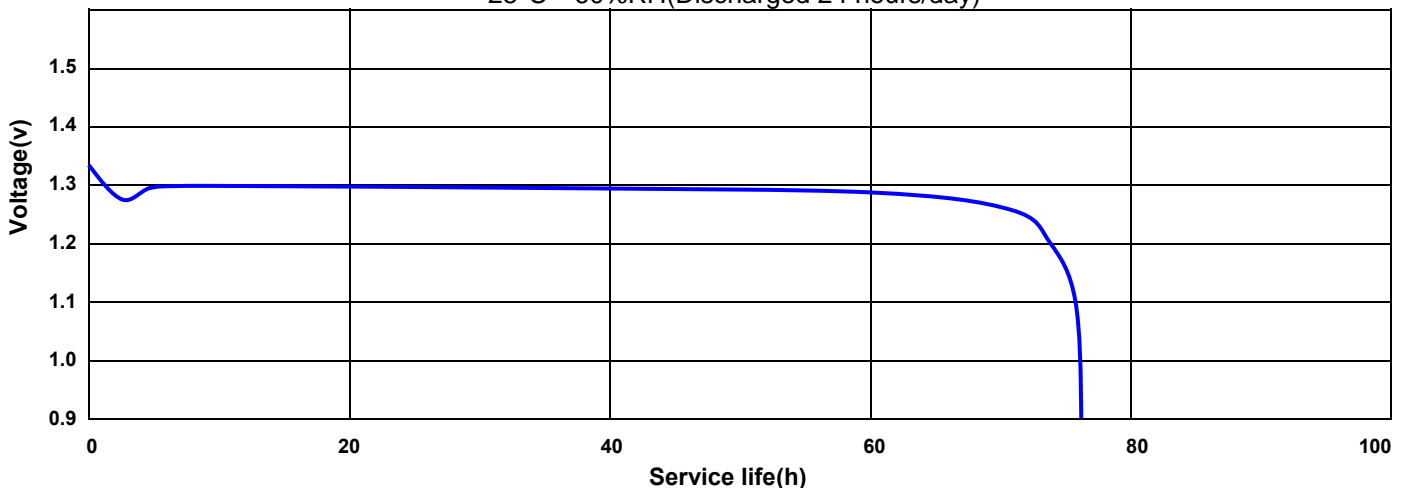

ZeniPower Battery Co., Ltd.

Building 10, Xiang Zhou North Industry Park,
Zhuhai, GD 519002, China
E-mail: info@zenipower.com
Home Page: www.zenipower.com
Tel: +86-756-252 6620 Fax: +86-756-252 6630

This data sheet is subject to change without prior notice.
Contact us for the latest information. Contents here do not
constitute a warranty. Feb. 2016